

Billi Sahara Plus 320 with XR Remote Dispenser & Gooseneck Mixer

The Sahara Boiling and Ambient (still) drinking water system, is a commercial capacity system, that maintains Billi's core design principles of space saving and vent-free installation. Offering both boiling temperature water and a bottomless supply of filtered ambient temperature water, the Sahara range is convenient and highly functional.

This system also serves as a point of use hot water system, for tea preps and breakout spaces with the addition of a mixer tap, providing Hot and Cold water for the sink.

The XR remote dispenser is an innovative and thoughtful design, with the potential for ambulant or wheelchair inclusive access via the remote control panel.

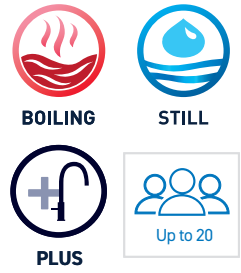

Features



XR Remote Dispenser



Gooseneck Mixer



Sahara Plus 320 Under-Bench Unit



Finishes

Standard Finish



CH - Chrome

Add the relevant Finish Code to the Product code to complete your specification, eg. 943025RGCH-LF

Accessories

992800 - 70mm Riser & Font



992820 - 70mm Riser



992803 - 120mm Riser & Font



992830 - 120mm Riser



990720 - Tubing Extension Kit for X series dual temp dispensers 2mtrs

Product Specifications

Water Type	BAHA
Dispenser	R - XR Remote Dispenser
Mixer Tapware	G - Gooseneck Mixer
Product Code	943025RG
Warranty	3 years manufacturers warranty
Under-Bench Dimensions	180mm(W) x 340mm (H) x 460mm (D)
Boiling Output	Up to 120 cups per hour
Chilled Output	N/A
Sparkling Output	N/A
50°C Hot Water Output	Up to 25L per hour
Min / Max Dispenser Temp	Ambient / 99°C
Power Plug	10 amp
Power Rating	1600W, 220-240V ~ 50-60Hz
Water Pressure	Min. 250kPa
Ecolabel	N/A
EPD	N/A
Greenstar Contribution	N/A
Watermark License	WM-021525 (unit), WM-25901 (tap)
Lead Free	✓
Section J7.7 (NCC)	✓
WELS	6 Star - 0133
WELL	Cornerstone Membership
Management Systems	Every Billi drinking water appliance is manufactured under the strictest standards and is certified in accordance with: ISO9001 for QMS (FS 790754), ISO14001 for EMS (EMS 801468) and ISO45001 for OSHS (OHS 801469).
Food Handling	HACCP License No. PE-138-BIL-R1-02
Filtration	994051 - 5.0 Micron supplied standard

Scan the QR code access our Revit families on
bimstore

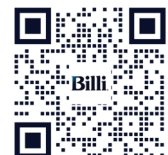

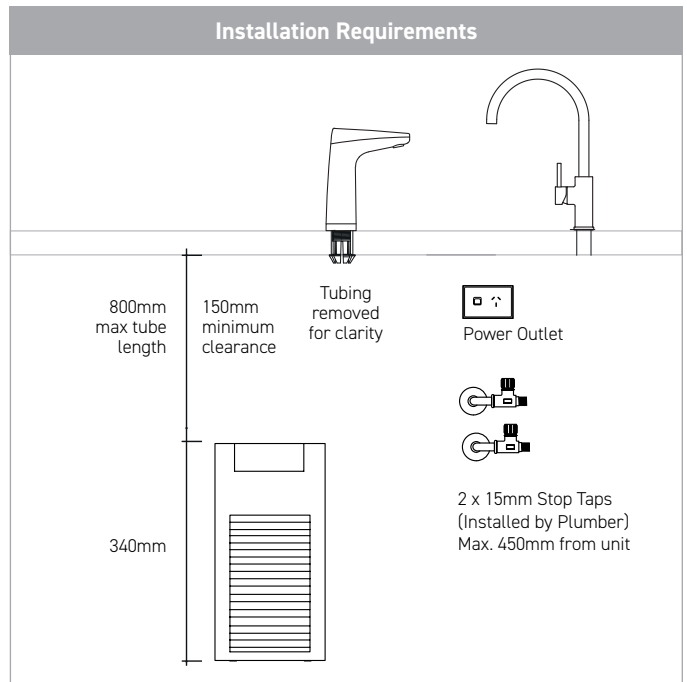
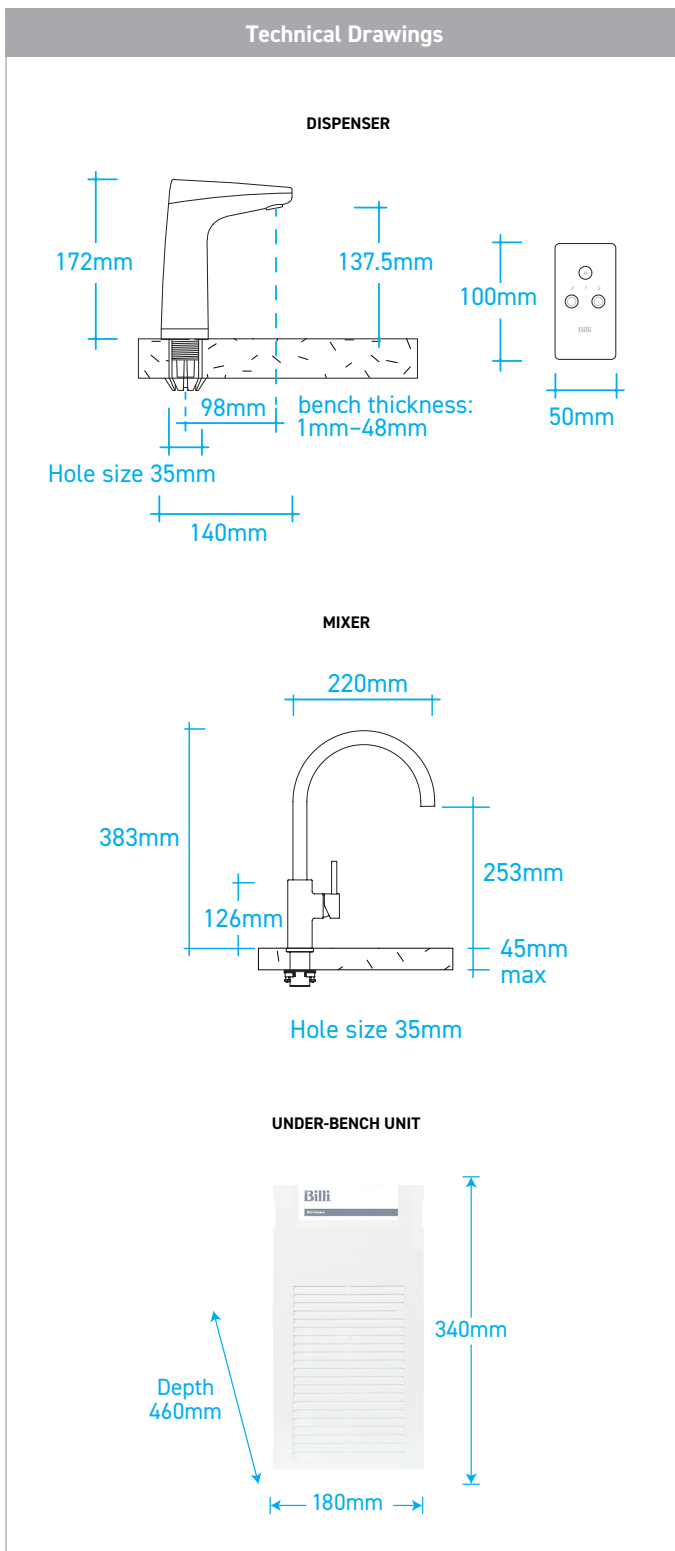

Installation Notes

- Electrical** A standard 10 amp power outlet is required, located no further than 1000mm from the underbench unit. The system is supplied with a 1 metre flex cord and plug.
- Water** Two (2) Cold 1/2" BSP (15mm) stop-taps with a male thread should be installed in an easily accessible position. Water supply must be microbiologically safe to drink, with a minimum dynamic water pressure of 250kPa and a maximum of 1000kPa.
- Pressure Valve** Integrated 500kPa pressure limiting and dual check valve is pre-installed to the unit inlet.
- Stone Benches** Billi has a no-cut policy regarding all stone benches in compliance with regulations. The safety of our team and customers remains Billi's top priority.
- Ventilation** No joinery ventilation or accessories are required for this Billi product (no waste heat).

Filtration – Most Recommended Replacement Filters

Billi range of premium filters utilize BWT's unique FibronX® technology, providing superior taste, water quality, filter life longevity and peace of mind when it comes to hygiene.



*Drawings are for guidance during Specification, refer to Installation requirements for final install. All efforts are made to ensure Compliance & Certifications claims are current, however this is subject to change without notice. Billi assumes no liability or responsibility for out of date information

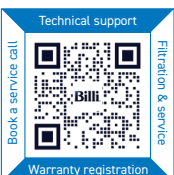

Please scan the QR code for all support information.

Billi Australia Pty Ltd
P 1800 812 321
W www.billi.com.au

Billi New Zealand Ltd
P 0800 636 0 636
W www.billi.co.nz

